

1968 Installation Instructions - Column Shift Automatic Transmission Cars

STOP:

This kit is intended for the modification of the existing dash, engine, and front light harnesses for an “**original**” column shifted automatic transmission car. If your vehicle is not an “**original**” column shift automatic car, this kit is incorrect for your vehicle and will not work in your vehicle. If you are unsure of the original configuration of your vehicle or are completely re-configuring your vehicle, American Autowire suggests that your purchase a complete set of Factory-Fit replacement harnesses that can be tailored to the final configuration desired for your vehicle.

The instructions provide a step by step procedure to add the dash harness wiring extension necessary to plug into the console gauge harness in order to complete the wiring circuits necessary to operate the console gauge package option. To complete the wiring it is also necessary to modify both the engine and front light harnesses. Wires and instructions for this modification are also included in this kit. This kit does not include the console gauge harness. It will be necessary to purchase part number CA85114 if your console gauge package does not already have an existing console gauge harness.

Please refer to the pictorial view of the harness on page 3 and the connector diagrams on page 4 for a detailed view of the connector cavity indexing. These drawings will be referenced throughout the installation of this kit. The drawings on page 4 show the wire colors in the connector cavities as they appear before starting the conversion and after completing the conversion.

DASH SIDE MODIFICATIONS

AMMETER GAUGE - 1968

1. Connect the black wire from the Console Gauge Extension Harness Connector location 7 to the fuse block bulkhead connector location S-A. (see wire 105A on page 3).
2. Connect the black/white wire from the Console Gauge Extension Harness Connector location 8 to the fuse block bulkhead connector location S-B. (see wire 106A on page 3).

FUEL GAUGE - 1968

1. Unplug the instrument cluster connector from the rear on the instrument cluster. The connector is numbered above each cavity.
2. Location 1 contains a tan wire. Remove the terminal and wire from the cluster connector. This wire will be eliminated from the circuit when you are complete. Cut off the terminal and tape the wire back out of the way.
3. Disconnect the rear body harness from the dash harness. Remove the tan wire from the dash side of the rear body connector, cut off the terminal and tape the wire back out of the way.
4. Replace this tan wire with the tan wire from location 12 of the Console Gauge Extension Harness Connector. (see wire 30 on page 3).
5. Reconnect the rear body harness to the dash harness. This now routes the fuel sender wiring directly to the console mounted fuel gauge.

OIL PRESSURE GAUGE - 1968

Oil pressure gauges are mechanical and require an oil line to be connected from the back of the oil pressure gauge to a fitting in the engine block where the original electrical sender was mounted. This fitting replaces the oil pressure warning light sender. Electrical modifications for the oil pressure gauge are necessary to remove the warning light circuit as follows:

1. Unplug the instrument cluster connector from the rear on the instrument cluster. The connector is numbered above each cavity.
2. Location 8 contains blue/white wire. Remove the terminal and wire from the cluster connector. This wire will be eliminated from the circuit when you are complete. But for now, it should be taped out of the way. This step is necessary as this cavity will be reused by the low fuel indicator connection that will be made in later steps.
3. Trace this wire to the fuse block bulkhead connector and remove the terminal and wire from location B-Z. This now removes the original oil pressure warning light circuit from service.

TEMPERATURE GAUGE - 1968

1. Unplug the instrument cluster connector from the rear on the instrument cluster. The connector is numbered above each cavity.
2. Location 2 contains two dark green wires. Remove the terminal and wires from the cluster connector. This wire will be eliminated from the circuit when you are complete, but for now it should be taped out of the way.
3. Originally, one of these wires was routed to the fuse block bulkhead connector and the other to the ignition switch.
4. Trace the wire to the fuse block bulkhead connector and remove the terminal and wire from location C-T.
5. Trace the wire to the ignition switch and disconnect the terminal and wire from the ignition switch. This now removes the original dash mounted temperature warning light circuit from service as it is no longer used.
6. Connect the dark green wire from location 11 of the Console Gauge Extension Harness Connector to fuse block bulkhead connector location C-T. (see wire 35A on page 3). This now routes the temperature sender lead wire directly from the fuse block bulkhead connector to the gauge harness connector. Note that a new temperature sender is necessary for the temperature gauge versus the one used for warning lights

LOW FUEL INDICATOR LIGHT - 1968

1. Plug the yellow wire from location 2 of the Console Gauge Extension Harness Connector into location 8 of the instrument cluster connector. (see wire 952 on page 3).
2. Special Note. Be sure the low fuel indicator unit you are using is designed for a 1968-69 Camaro. Units designed for a 1968-69 Camaro function differently from those used in the 1967 Camaro. Low fuel indicators used for the 1967 Camaro will not work in 1968 vehicles.

GENERATOR WARNING LIGHT - 1968

1. Unplug the speedometer cluster connector from thr rear of the instrument cluster. The connector is numbered above each cavity.
2. Disconnect the brown wire from the speedometer cluster connector location 11 and tape the end to prevent grounding. This wire was originally used for the “GEN” warning light which is not used in the instrument cluster for console gauge equipped cars.



CA6809

CONSOLE GAUGE CONVERSION HARNESS
1968 CAMARO
COLUMN SHIFT AUTOMATIC TRANSMISSION

©1986,1990,1993, 2010
American Autowire
all rights reserved

Information and illustrations on this instruction sheet are the property of American Autowire, Inc. No part of this sheet may be reproduced without licensing approval from American Autowire, Inc.

American Autowire -150 Heller Place #17 W - Bellmawr, N.J. 08031 - 856-933-0801

92969731 INSTRUCTION SHEET

REV 5.0 4/17/2024

CONSOLE COURTESY LIGHT - 1968

Select the white wire originating from location 5 of the Console Gauge Extension Harness Connector. This wire is used for the courtesy light at the rear of a stock console. Connect as follows:

1. Remove the white wire from the headlight switch connector.
2. Plug the white wire from location 5 of the Console Gauge Extension Harness Connector into the same headlight switch cavity that the original white wire was removed from. (see wire 156 on page 3).
3. Plug the original white wire removed from the headlight switch connector into the white pigtail jumper wire using the supplied locking connector body. This now activates the console courtesy light circuit.

POWER CONNECTIONS - 1968

There may be existing connections plugged into the fuse box to accommodate accessories requiring battery power, ignition power, and instrument lights. When plugging in the following connections, the existing connections should first be unplugged and plugged into the pigtail lead attached to each of the battery, ignition, and instrument light wires defined in the following instructions.

1. Plug the orange wire from location 1 of the Console Gauge Extension Harness Connector to a constant battery power terminal on the front of the fuse panel. (see wire 140 on page 3).
2. Plug the gray wire from location 10 of the Console Gauge Extension Harness Connector to the instrument light terminal on the front of the fuse panel. (see wire 8 on page 3).

AUTOMATIC TRANSMISSION - 1968

1. Locate the neutral safety switch at the base of the original steering column. Unplug the connectors containing the purple, and purple and white wires and the pink and light green wires, and plug them into the two mating connectors on the gauge extension harness. This now routes the neutral safety switch and backup light circuits to the console.
2. Console harness CA85114 will complete the connections to a new neutral safety switch located on the shifter assembly in the console

TACHOMETER - 1968

1. Unplug the instrument cluster connector from the rear on the instrument cluster. The connector is numbered above each cavity.
2. Insert the cluster connector terminal end of the brown wire taped into the gauge extension harness into location 2 of the instrument cluster connector. (see wire 121A on page 3 at the center of the harness with wires 952, 140, 30, and 156).
3. Insert the other end of this wire into the fuse block bulkhead connector location A-X. (see wire 121A on page 3 at the far right hand side of the harness with wires 35A, 106A, 105A, 39, 140, and 8).
4. Original 1968 Tic-Tock tachometers had a clock mounted inside the tachometer body. Connect the orange power wire to the clock power terminal. (see wire 140 on page 3 at the center of the harness with wires 952, 121A, 30, and 156).

ENGINE SIDE MODIFICATIONS

AMMETER GAUGE - 1968

1. Select the long black wire with the orange fusible link and connect the fusible link end to the positive battery junction block located behind the battery.
Connect the other end of this wire into location S-A of the front light harness connector. (see wire 105B on page 3).
2. Select the long black/white wire with the orange fusible link and connect the fusible link end to one of the positive battery screws on the horn relay.
Connect the other end of this wire into location S-B of the front light harness connector. (see wire 106B on page 3).

TEMPERATURE GAUGE - 1968

1. Select the dark green temperature sender wire with the loom covering. (see wire 35B on page 3).
2. Remove the existing dark green wire from location T-C of the front light harness connector and replace it with the new dark green wire with the blade terminal end to location T-C of the front light harness connector.
3. Connect the other end with the sender connector to the temperature sender. All warning light and gauge equipped cars used the same wiring to the temperature sending unit. The difference is in the sending unit, the function of the sending unit, and the connector to the sending unit, not the wiring. The warning light sending unit must be replaced with a sending unit for gauges. Original GM sending units for gauge equipped cars are recommended, however, replacement units are made by many after market component suppliers. American Autowire can supply this sender under part number 06400759.

FUEL GAUGE - 1968

No electrical modifications are necessary.

GENERATOR WARNING LIGHT - 1968

No electrical modifications are necessary.

OIL PRESSURE GAUGE - 1968

Oil pressure gauges are mechanical and require an oil line to be connected from the back of the oil pressure gauge to a fitting in the engine block where the original electrical sender was mounted. This fitting replaces the oil pressure warning light sender. After the old sending unit is replaced by a mechanical fitting and line, the blue wire originally connected to the sending unit must be disconnected from the engine harness fuse block connector at location B-Z as follows:

1. Remove the terminal and wire from the engine harness connector location B-Z and cut off the terminal.
2. Disconnect the blue wire from the old sending unit, cut off the terminal, and pull the wire through the harness and discard it.

TACHOMETER - 1968

1. Select the brown wire with the right angle spade terminal on one end and a male terminal on the other end. (see wire 121B on page 3).
2. Connect the male terminal end to location A-X of the engine harness connector.
3. Connect the right angle spade terminal end to the distributor (-) side of the ignition coil.

CA6809

CONSOLE GAUGE CONVERSION HARNESS 1968 CAMARO COLUMN SHIFT AUTOMATIC TRANSMISSION

©1986,1990,1993, 2010
American Autowire
all rights reserved

Information and illustrations on this instruction sheet are the property of American Autowire, Inc. No part of this sheet may be reproduced without licensing approval from American Autowire, Inc.

American Autowire -150 Heller Place #17 W - Bellmawr, N.J. 08031 - 856-933-0801

CONSOLE GAUGE DASH HARNESS EXTENSION

Dash Side Connections

- Low Fuel Warning Light (Instrument cluster connector location 8)
- Tic-Tock tachometer clock power connection
- Tachometer Connection (Instrument cluster connector location 2)
- Neutral Safety Switch --- connections ---
- Neutral Safety Switch
- Backup Lights
- Courtesy Lights (plug into headlight switch connector)

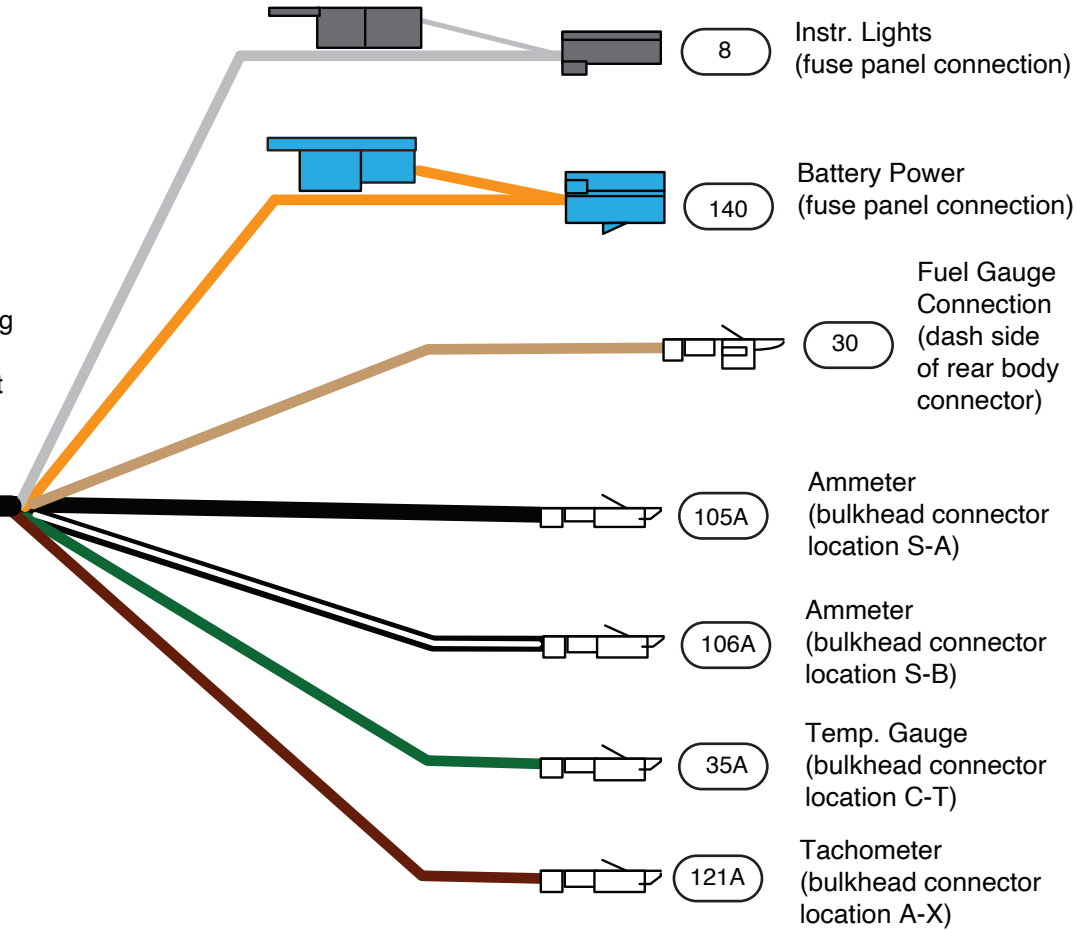
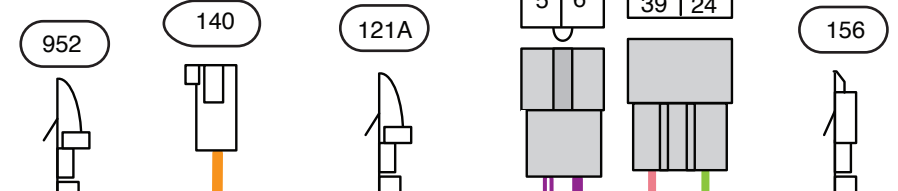

GAUGE HARNESS EXTENSION CONNECTOR

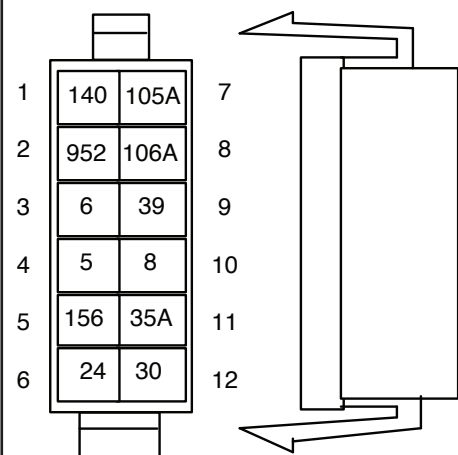

PLUG CONSOLE HARNESS CA85114 INTO THIS NEW CONSOLE GAUGE HARNESS EXTENSION CONNECTOR

Engine Side Connections

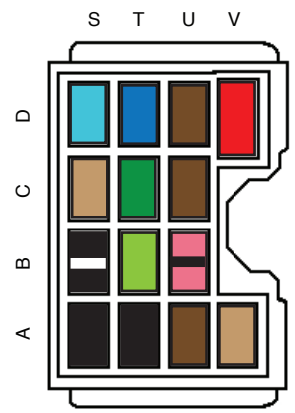

- Temp. Gauge (engine connector location C-T)
- Ammeter (front light connector location S-A)
- Ammeter (front light connector location S-B)

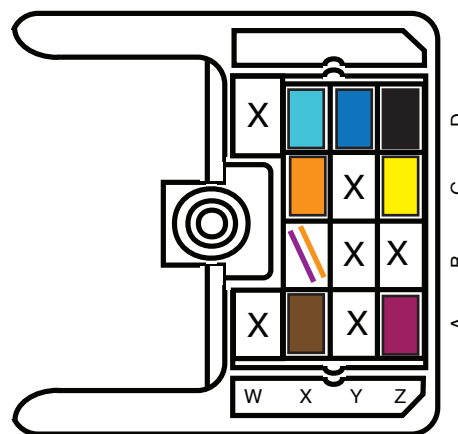
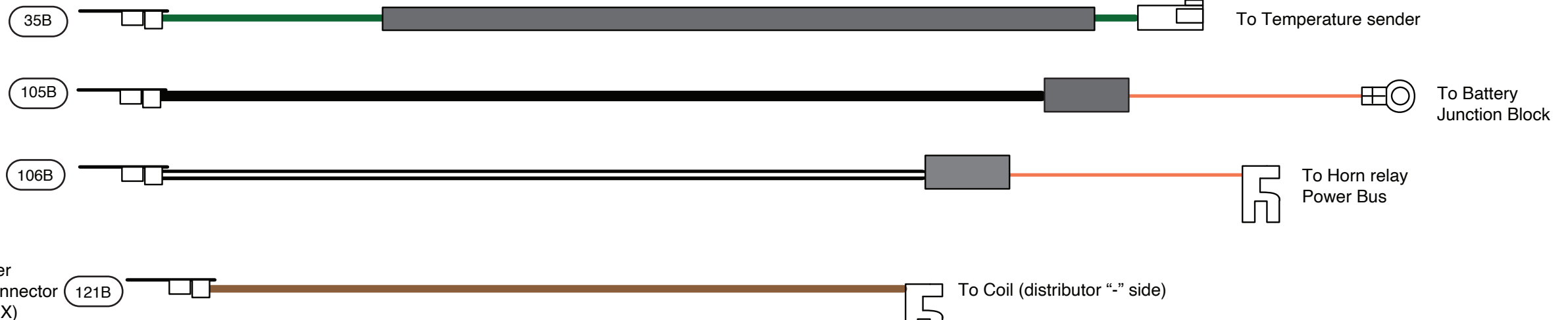

- Tachometer (engine connector location A-X)

CA6809

CONSOLE GAUGE CONVERSION HARNESS
1968 CAMARO
COLUMN SHIFT AUTOMATIC TRANSMISSION

BEFORE CONVERSION

1968-69 FRONT LIGHT HARNESS CONNECTOR (viewed from terminal side opposite of the wire entry)

1968-69 ENGINE HARNESS CONNECTOR (viewed from terminal side opposite of the wire entry)

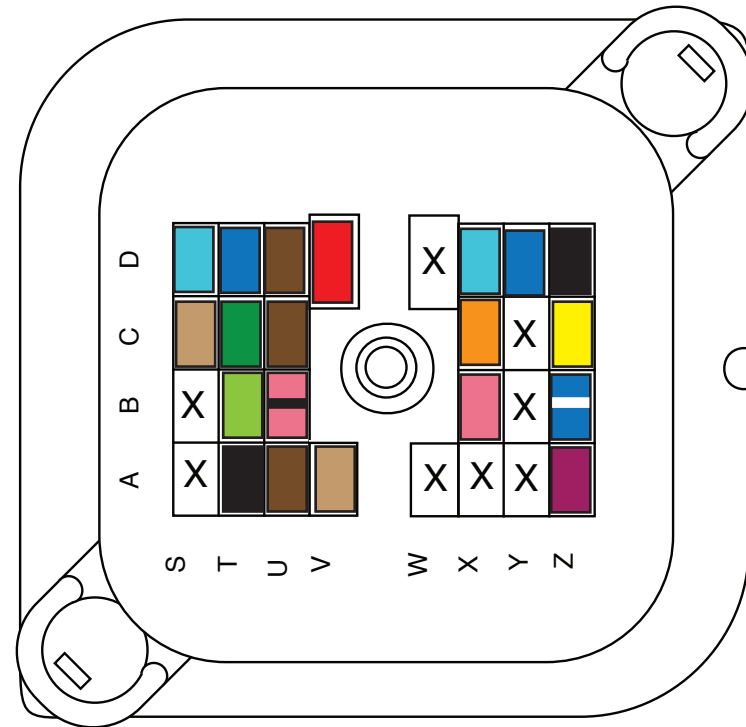
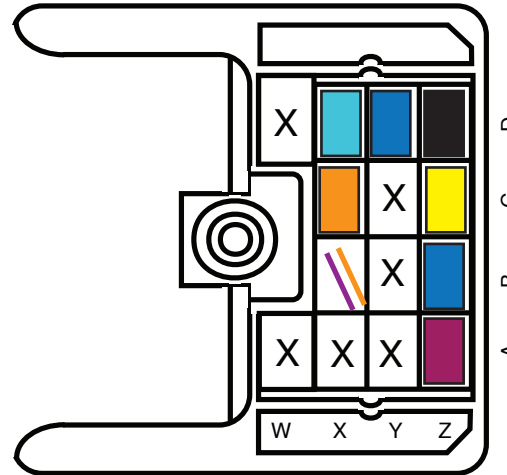
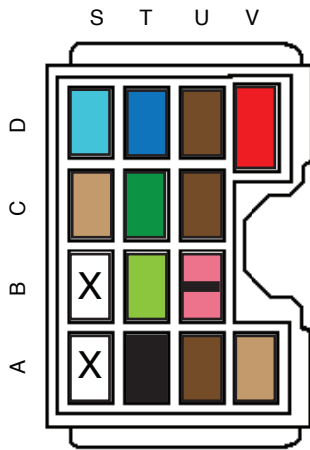

1968 - 1969 FUSE BLOCK BULKHEAD CONNECTOR (viewed from wire entry side with the fuse panel disconnected)

1968 INSTRUMENT CLUSTER CONNECTOR (viewed from terminal side opposite of the wire entry)

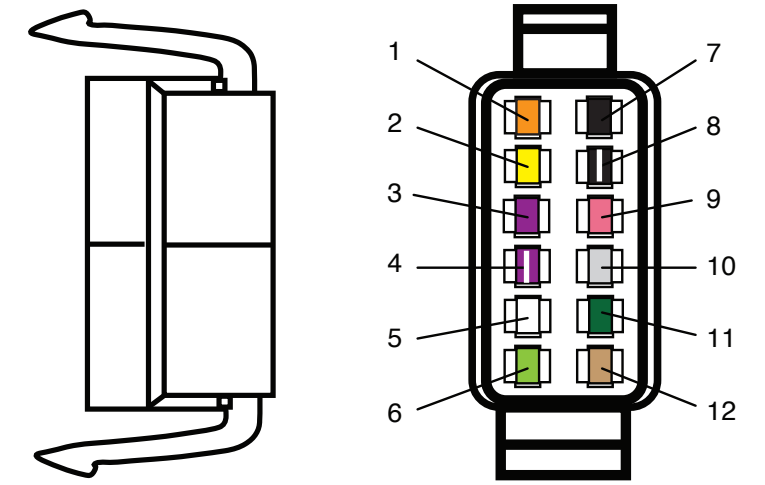
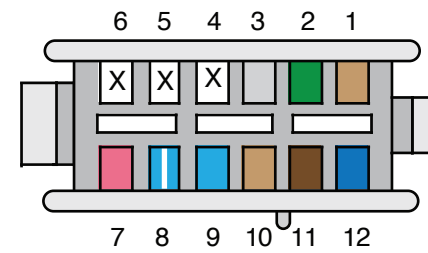

GAUGE HARNESS CONNECTOR SUPPLIED ON THE CONSOLE EXTENSION HARNESS (viewed from the terminal side opposite of the wire entry)

CONSOLE WIRING APPLICATION CHART

wire	color	application
1	orange	Rear console light
2	yellow	Low fuel indicator lamp
3	purple	Neutral safety switch (automatic only)
4	purple/wht stripe	Neutral safety switch (automatic only)
5	white	Rear console light
6	light green	Neutral safety switch - backup light (automatic only)
7	black	Ammeter gauge
8	black/wht stripe	Ammeter gauge
9	pink	Neutral safety switch - backup light power (automatic only)
10	pink	Fuel and temperature gauge power
11	gray	Gauge lamps
12	dark green	Temperature gauge
	tan	Fuel gauge
	black	console gauge cluster ground

AFTER CONVERSION

1968-69 FRONT LIGHT HARNESS CONNECTOR (viewed from terminal side opposite of the wire entry)

1968-69 ENGINE HARNESS CONNECTOR (viewed from terminal side opposite of the wire entry)

1968 INSTRUMENT CLUSTER CONNECTOR (viewed from terminal side opposite of the wire entry)

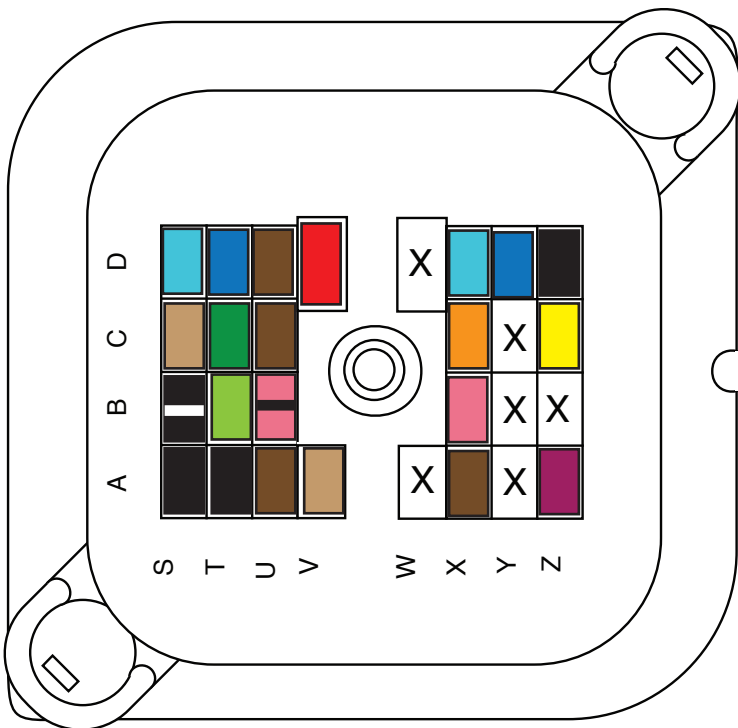

1968 - 1969 FUSE BLOCK BULKHEAD CONNECTOR (viewed from wire entry side with the fuse panel disconnected)

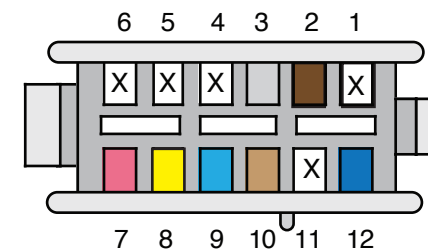
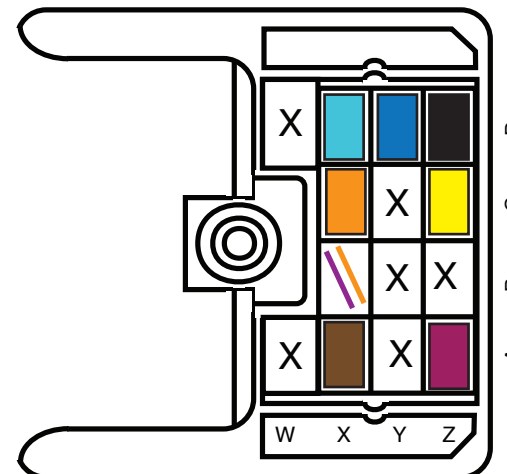
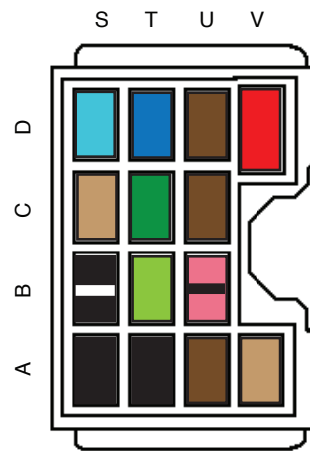

CA6809

**CONSOLE GAUGE CONVERSION HARNESS
1968 CAMARO
COLUMN SHIFT AUTOMATIC TRANSMISSION**

©1986,1990,1993, 2010 American Autowire all rights reserved

Information and illustrations on this instruction sheet are the property of American Autowire, Inc. No part of this sheet may be reproduced without licensing approval from American Autowire, Inc.

American Autowire -150 Heller Place #17 W - Bellmawr, N.J. 08031 - 856-933-0801